

Mining Master Smart

Type:	KTC145.1 Breuer
Partnumber	44000011
Drawing No.	G074-4080
Creator	J. Strauß
Date	19.07.2019
Rev. Date	19.07.2019

Walter-Becker-Straße 1
66299 Friedrichsthal
Fon: +49 6897 / 857 - 0
Fax: +49 6897 / 857 - 188

Becker MINING EUROPE GmbH
<http://www.becker-mining.com>
e-mail: info@becker-mining.com

Contents

no.	installation	Page	Description	Date	Creator	Rev. Date
1	44000010	1	Deckblatt	30.01.20		02.09.14
2	44000010	1	=44000010-X11	20.02.20		
3	44000010	1.1	=44000010-X11	20.02.20		
4	44000010	2	=44000010-XP2	20.02.20		
5	44000010	3	Contents	20.02.20		
6	44000010	100	Mechanical construction Supervision	22.5.19		
7	44000010	101	Mechanical construction Assembling rear side door	10.06.13		
8	44000010	102	Mechanical Assembling mounting plate	10.06.13		
9	44000010	200	Wiring plan INPUTS E0.0NL - E0.7NL	29.08.19		
10	44000010	201	Wiring plan FB006 Mod. Adr. 0	22.07.19		
11	44000010	202	Wiring plan External power supply	20.02.20		
12	44000010	203	Wiring plan Fieldbus line 0 AST	13.06.18		
13	44000010	204	Wiring plan RS485 Fieldbus line 1 - BTS	19.02.20		
14	44000010	205	Wiring plan basic module	10.06.13		
15	44000010	206	Wiring plan FB 043 DUST module	30.01.20		
16	44000010	207	Wiring plan Ribbon cable	13.06.18		
17	44000010	300	Data sheet Display	29.07.19		
18	44000010	301	Data sheet MMS basic module	10.06.13		
19	44000010	302	Data sheet FB006	22.07.19		
20	44000010	303	Data sheet DUST module FB 043	30.01.20		
21		500	Bill of material	19.02.20		
22		600	Order list	19.02.20		

a			Date	19.07.2019		Becker MINING EUROPE GmbH Walter-Becker-Straße 1 66299 Friedrichsthal	Contents	Projekt title		= 44000011
b		Drawn	J. Strauß	Mining Master Smart				+		
c		Chkd.								
Rev.	Modification	Date	Name	Norm	Original	Subst. For	Replaced by	Drawing No.	G074-4080	Sheet3 + 18 Bl.

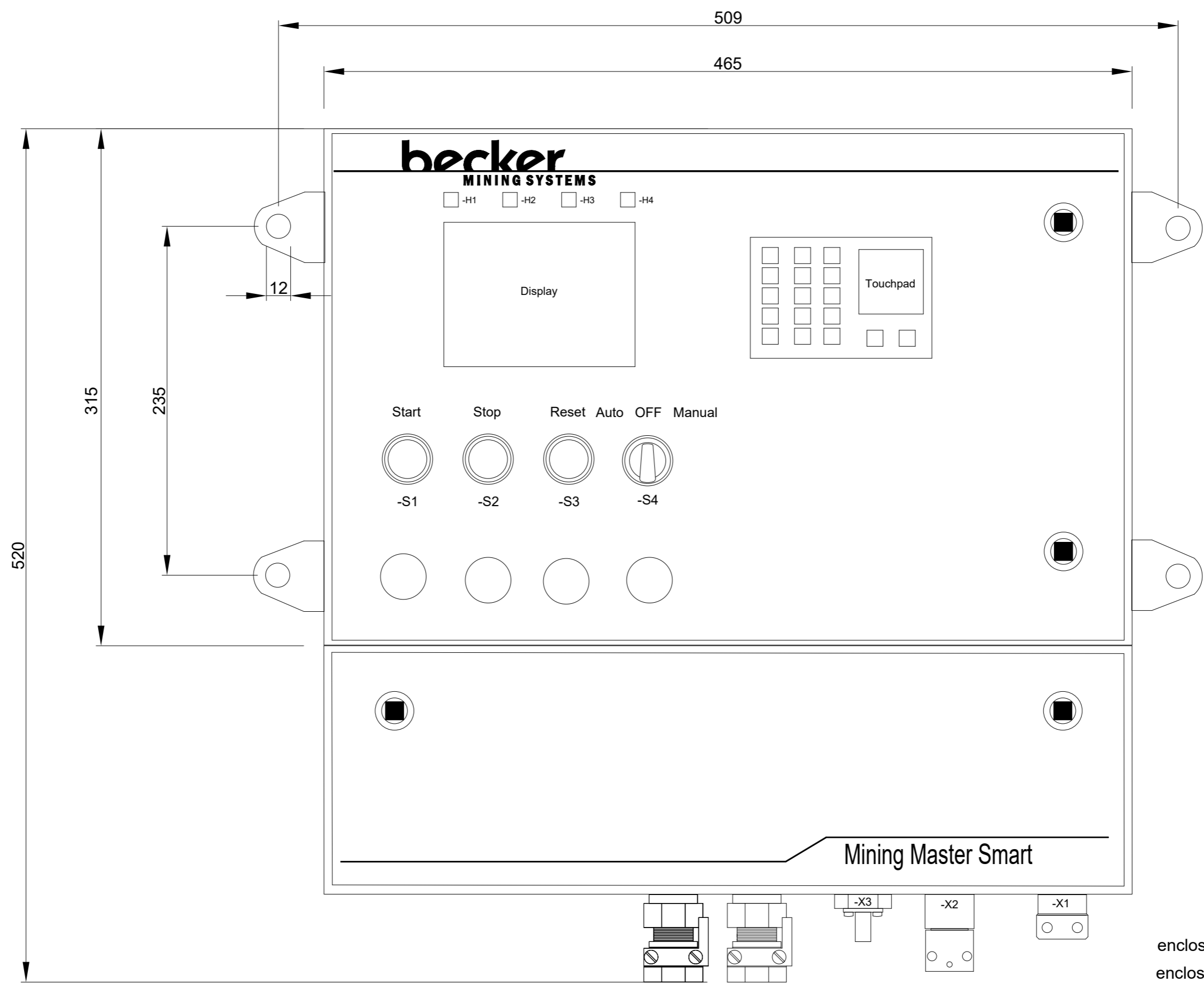

enclosure depth 140 mm
 enclosure depth 207 mm (with door)
 weight approx. 25 kg

a				Date	19.07.2019		Becker MINING EUROPE GmbH Walter-Becker-Straße 1 66299 Friedrichsthal	Mechanical construction Supervision	Projekt title	= 44000011	
b			Drawn	J. Strauß	Mining Master Smart				+		
c			Chkd.								
Rev.	Modification	Date	Name	Norm	Original	Subst. For	Replaced by		Drawing No. G074-4080	Sheet 100 +	18 Bl.

1 2 3 4 5 6 7 8

A

A

Rear door assembly

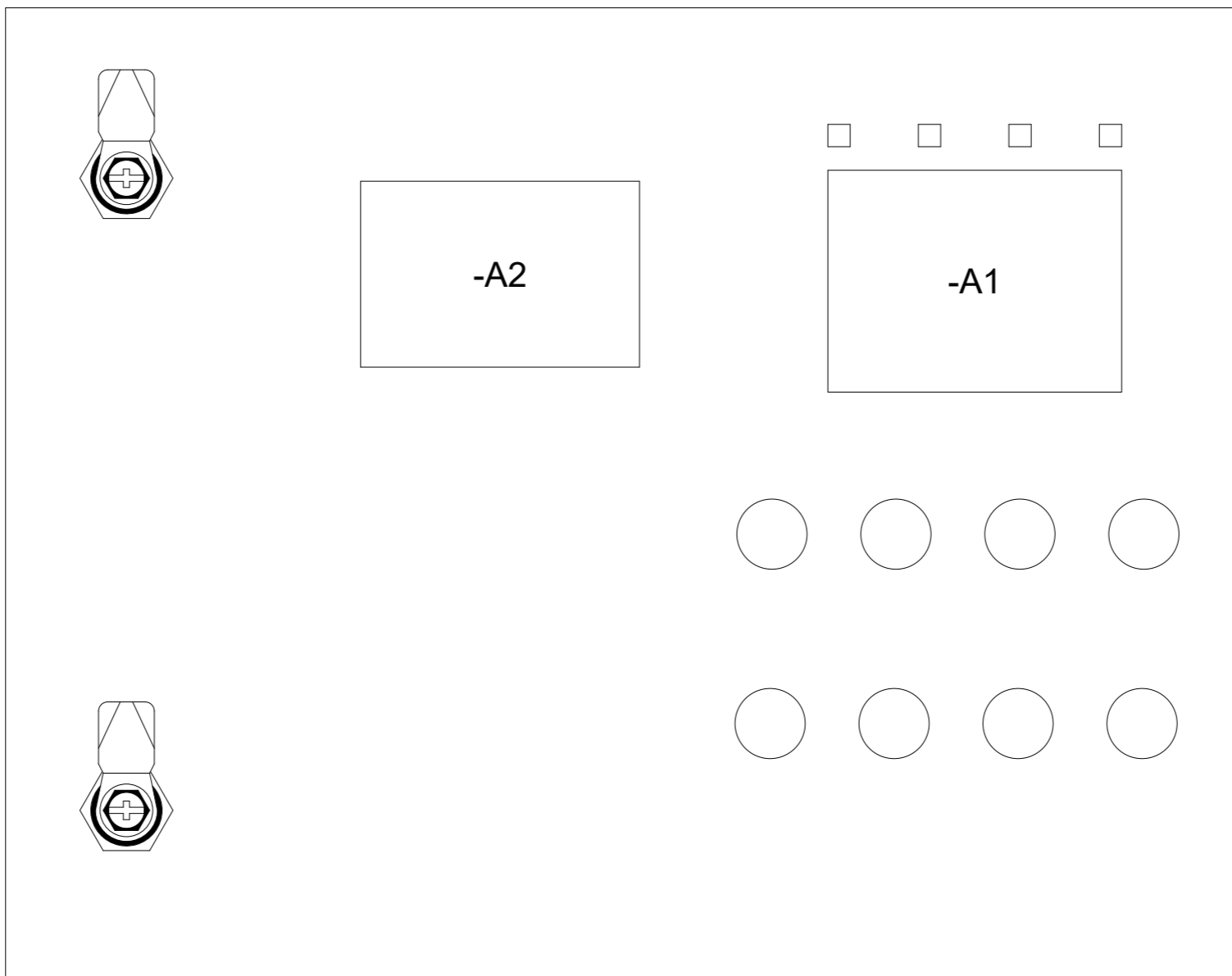

B

B

C

C

D

D

E

E

F

F

a				Date	19.07.2019		Becker MINING EUROPE GmbH Walter-Becker-Straße 1 66299 Friedrichsthal	Mechanical construction Assembling rear side door	Projekt title		= 4400011
b			Drawn	J. Strauß	Mining Master Smart				+		
c			Chkd.								
Rev.	Modification	Date	Name	Norm	Original	Subst. For	Replaced by		Drawing No.	Sheet101 +	
									G074-4080	18 Bl.	

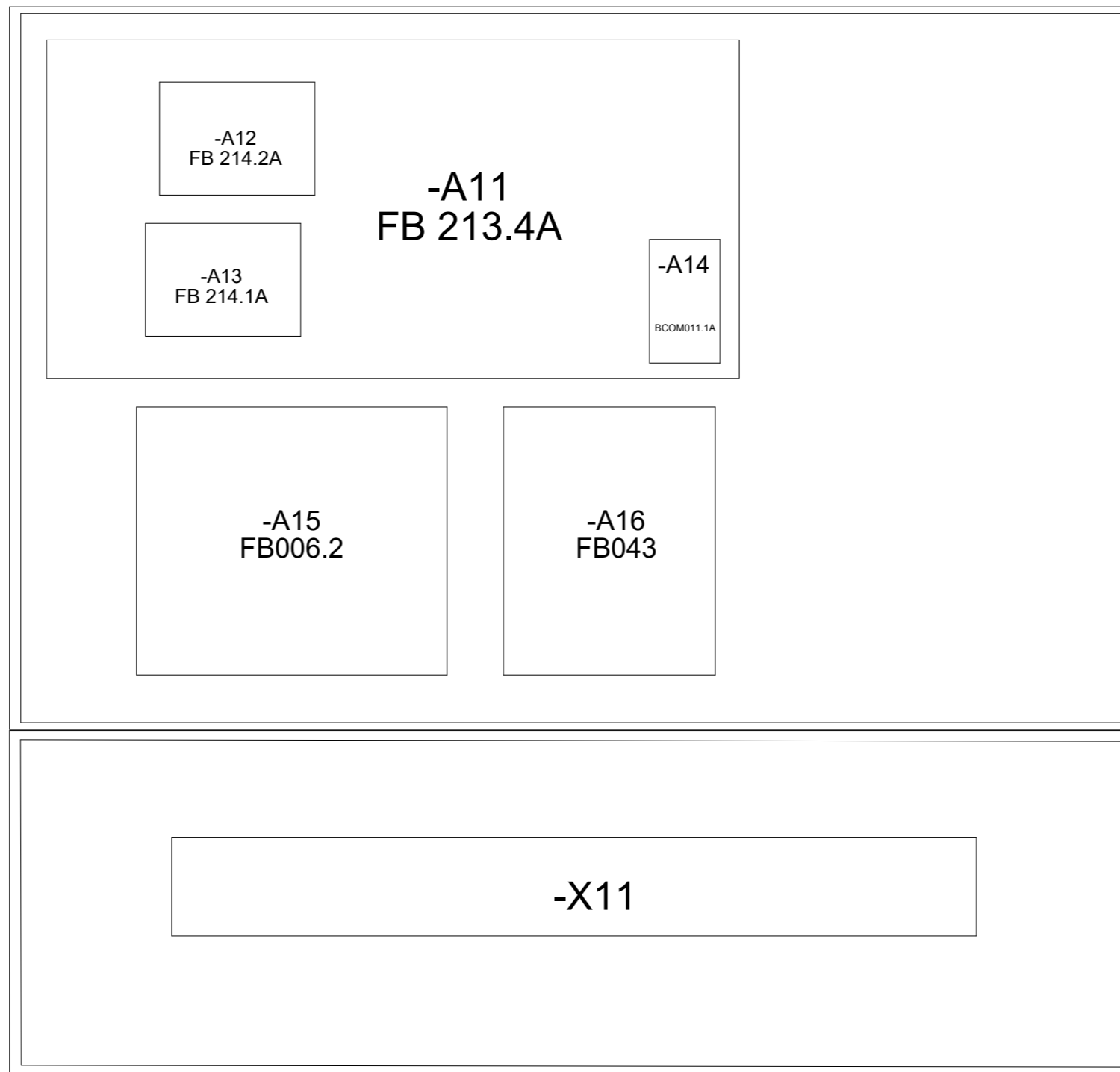

a				Date	19.07.2019
b				Drawn	J. Strauß
c				Chkd.	
Rev.	Modification	Date	Name	Norm	

becker
MINING EUROPE

Becker MINING EUROPE GmbH
Walter-Becker-Straße 1
66299 Friedrichsthal

Mechanical
Assembling mounting plate

Projekt title	44000011
Mining Master Smart	+
Drawing No.	Sheet102 +
G074-4080	18 Bl.

-A1 FB212.3A													
GND	GND	E0.7NL	E0.6NL	E0.5NL	E0.4NL	E0.3NL	E0.2NL	E0.1NL	E0.0NL	Emergency-Stop response		Emergency safety circuit	
X6-2.2	X6-2.1	X5-2.2	X5-2.1	X4-2.2	X4-2.1	X3-2.2	X3-2.1	X2-2.2	X2-2.1	X2-4.2	X2-4.1	X3-4.2	X3-4.1

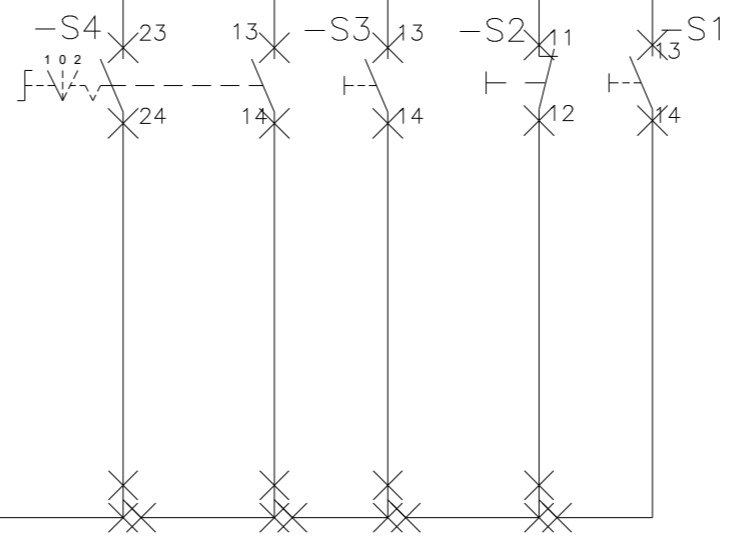

a				Date	19.07.2019		Becker MINING EUROPE GmbH Walter-Becker-Straße 1 66299 Friedrichsthal	Wiring plan INPUTS E0.0NL - E0.7NL	Projekt title		= 44000011
b			Drawn	J. Strauß	Mining Master Smart				+		
c			Chkd.								
Rev.	Modification	Date	Name	Norm	Original	Subst. For	Replaced by	Drawing No.		Sheet200 +	
								G074-4080		18 Bl.	

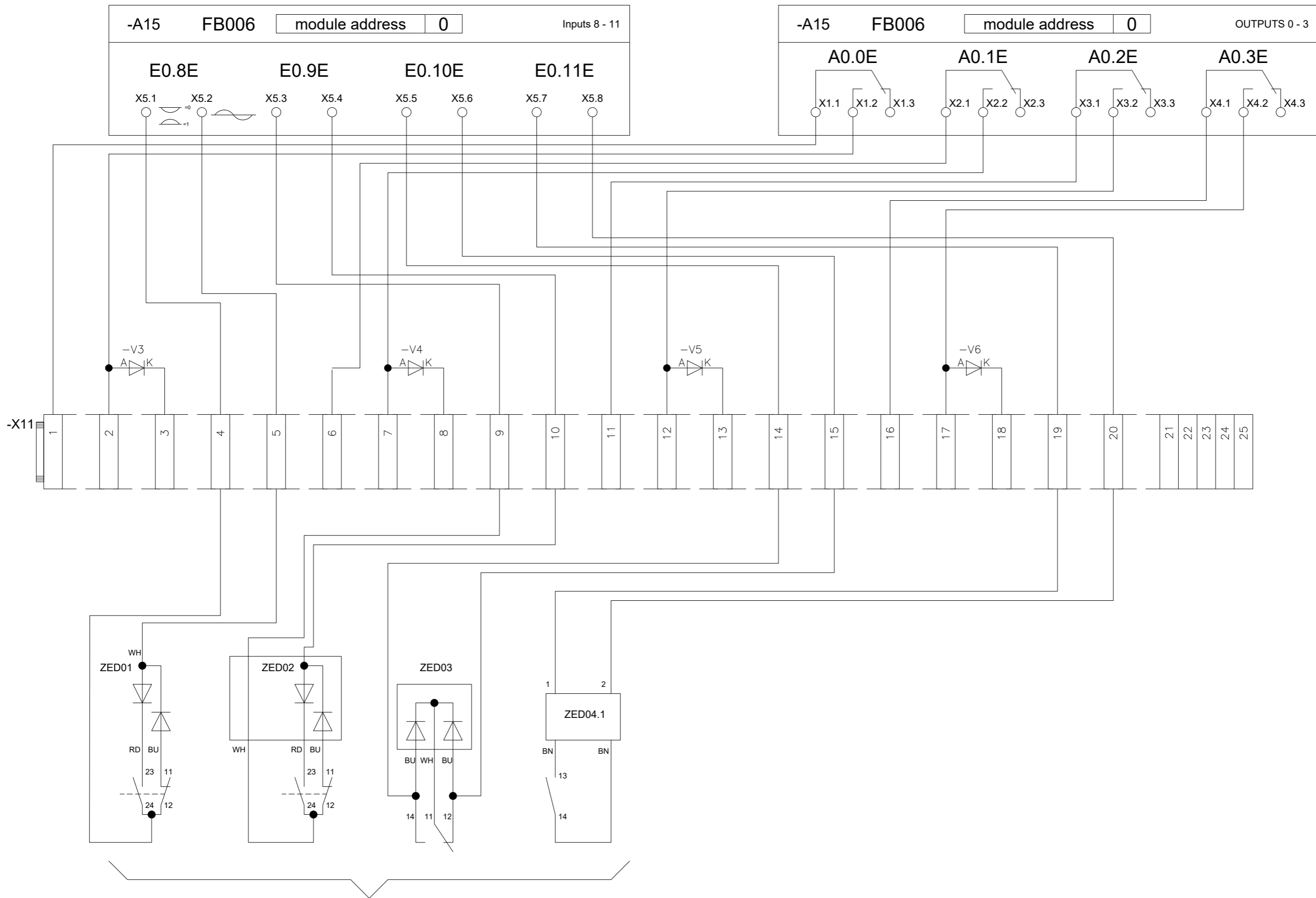

Connection examples

a				Date	19.07.2019		Becker MINING EUROPE GmbH Walter-Becker-Straße 1 66299 Friedrichsthal	Wiring plan FB006 Mod. Adr. 0	Projekt title	= 44000011
b			Drawn	J. Strauß	Mining Master Smart				+	
c			Chkd.							
Rev.	Modification	Date	Name	Norm	Original	Subst. For	Replaced by		Drawing No. G074-4080	Sheet201 + 18 Bl.

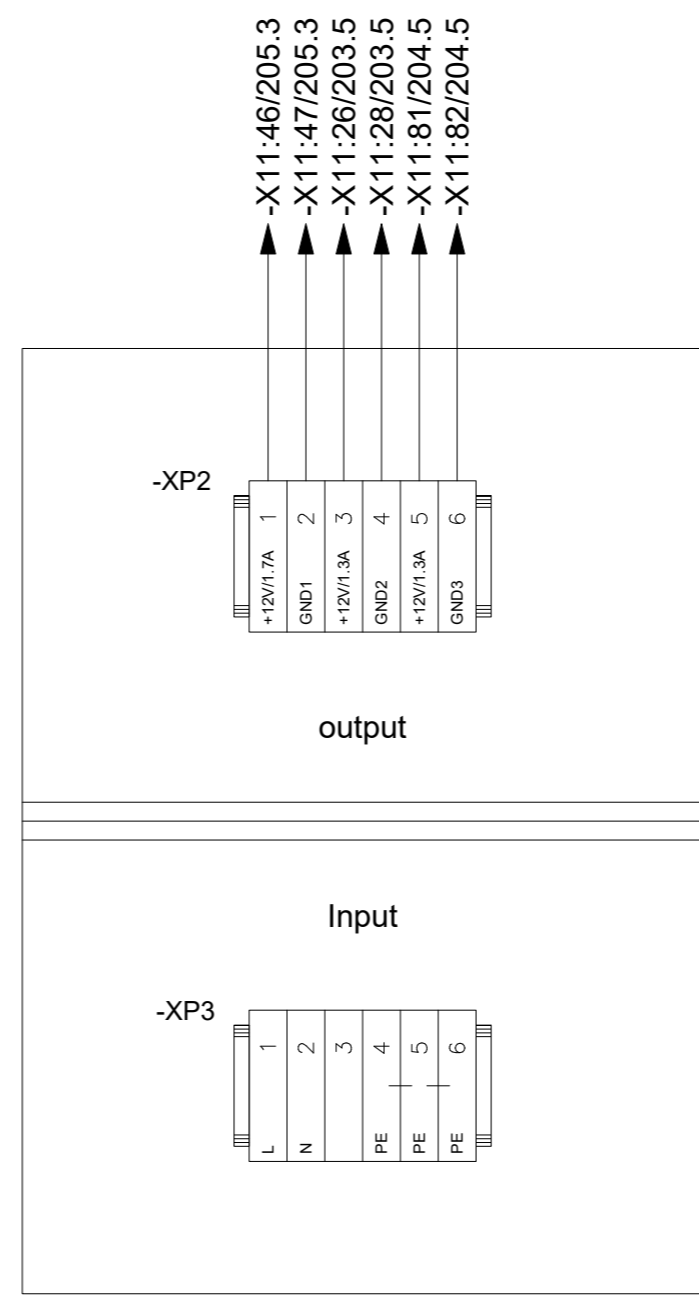

External power supply
KDW127

a				Date	19.07.2019		Becker MINING EUROPE GmbH	Wiring plan External power supply	Projekt title	= 44000011	
b			Drawn	J. Strauß	Walter-Becker-Straße 1		Mining Master Smart		+		
c			Chkd.		66299 Friedrichsthal				Drawing No.	Sheet 202 +	
Rev.	Modification	Date	Name	Norm	Original	Subst. For	Replaced by	G074-4080	18 Bl.		

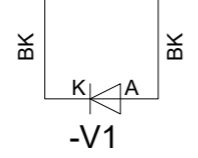
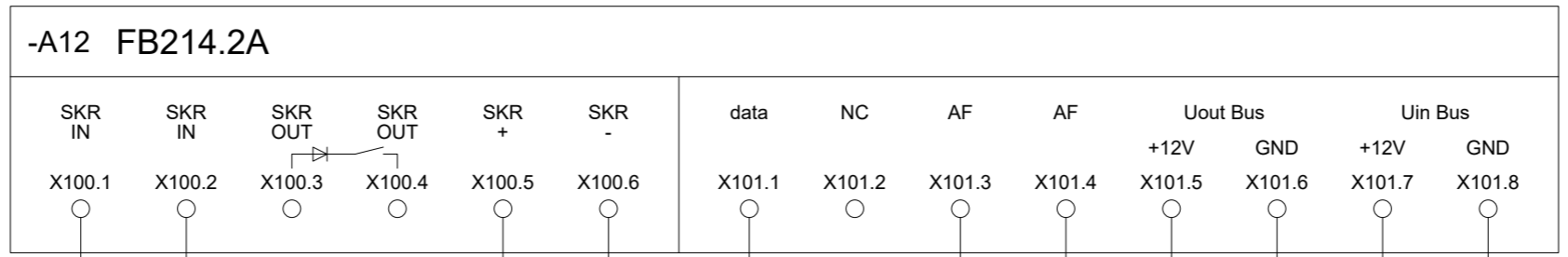

Individual cores paired and twisted in a clockwise direction

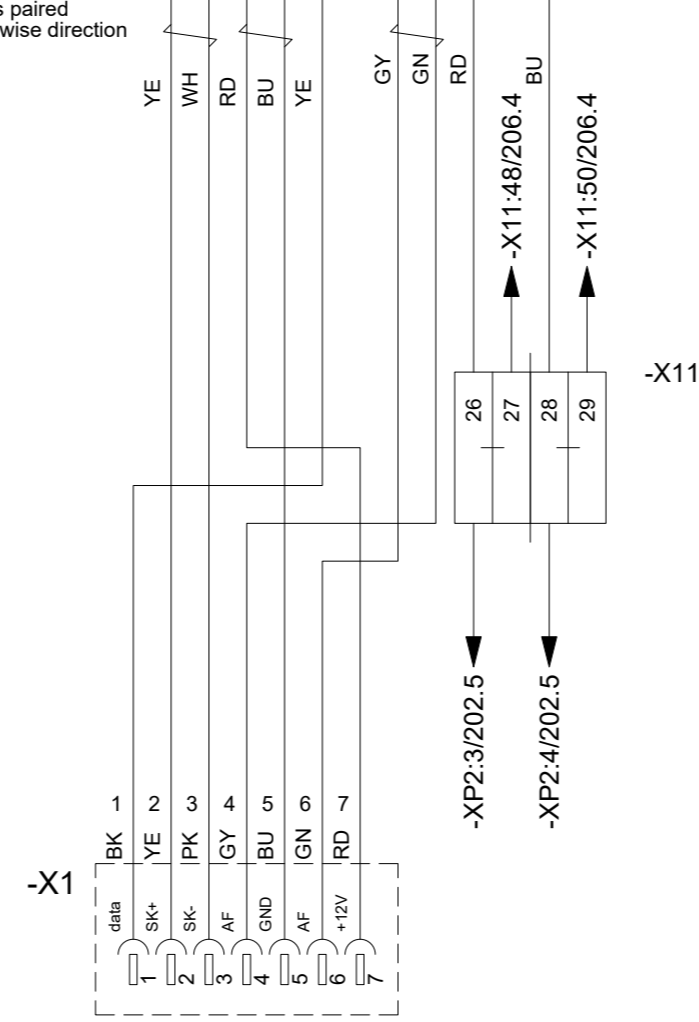

Fieldbus line 0
Ast

a				Date	19.07.2019		Becker MINING EUROPE GmbH Walter-Becker-Straße 1 66299 Friedrichsthal	Wiring plan Fieldbus line 0 AST	Projekt title	= 44000011	
b			Drawn	J. Strauß	Mining Master Smart				+		
c			Chkd.								
Rev.	Modification	Date	Name	Norm	Original	Subst. For	Replaced by		Drawing No.	G074-4080	Sheet 203 + 18 Bl.

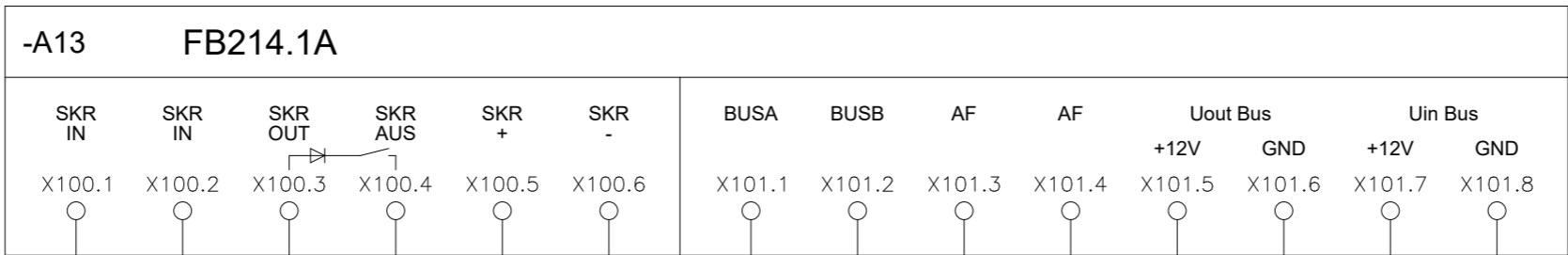

Individual cores paired and twisted in a clockwise direction

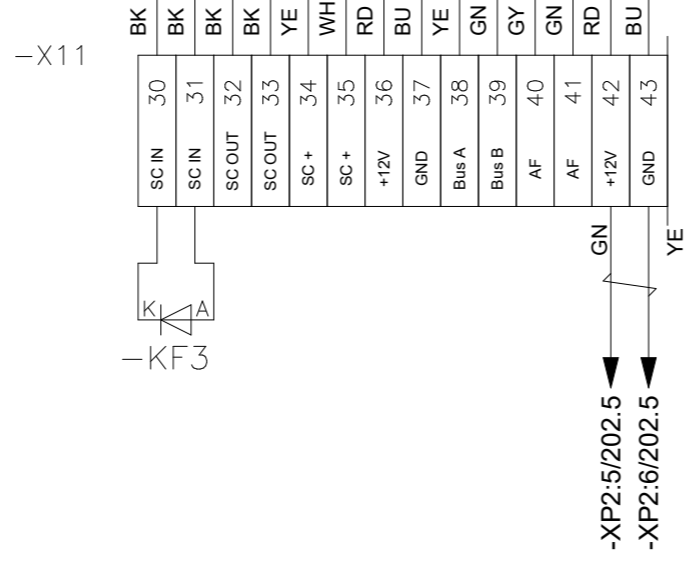

a				Date	19.07.2019		Becker MINING EUROPE GmbH Walter-Becker-Straße 1 66299 Friedrichsthal	Wiring plan RS485 Fieldbus line 1 - BTS	Projekt title	= 44000011	
b			Drawn	J. Strauß	Mining Master Smart				+		
c			Chkd.								
Rev.	Modification	Date	Name	Norm	Original	Subst. For	Replaced by		Drawing No.	G074-4080	Sheet204 + 18 Bl.

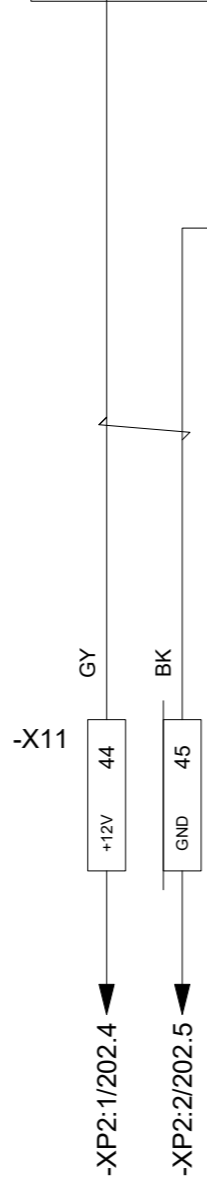
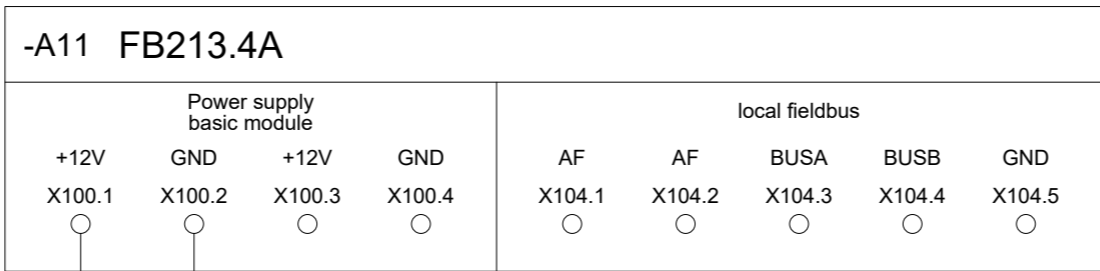

Individual cores paired and twisted in a clockwise direction

a				Date	19.07.2019		Becker MINING EUROPE GmbH Walter-Becker-Straße 1 66299 Friedrichsthal	Wiring plan basic module	Projekt title		= 44000011
b			Drawn	J. Strauß	Mining Master Smart				+		
c			Chkd.								
Rev.	Modification	Date	Name	Norm	Original	Subst. For	Replaced by	Drawing No.		Sheet205 +	
								G074-4080		18 Bl.	

Transmitter active / Receiver passive

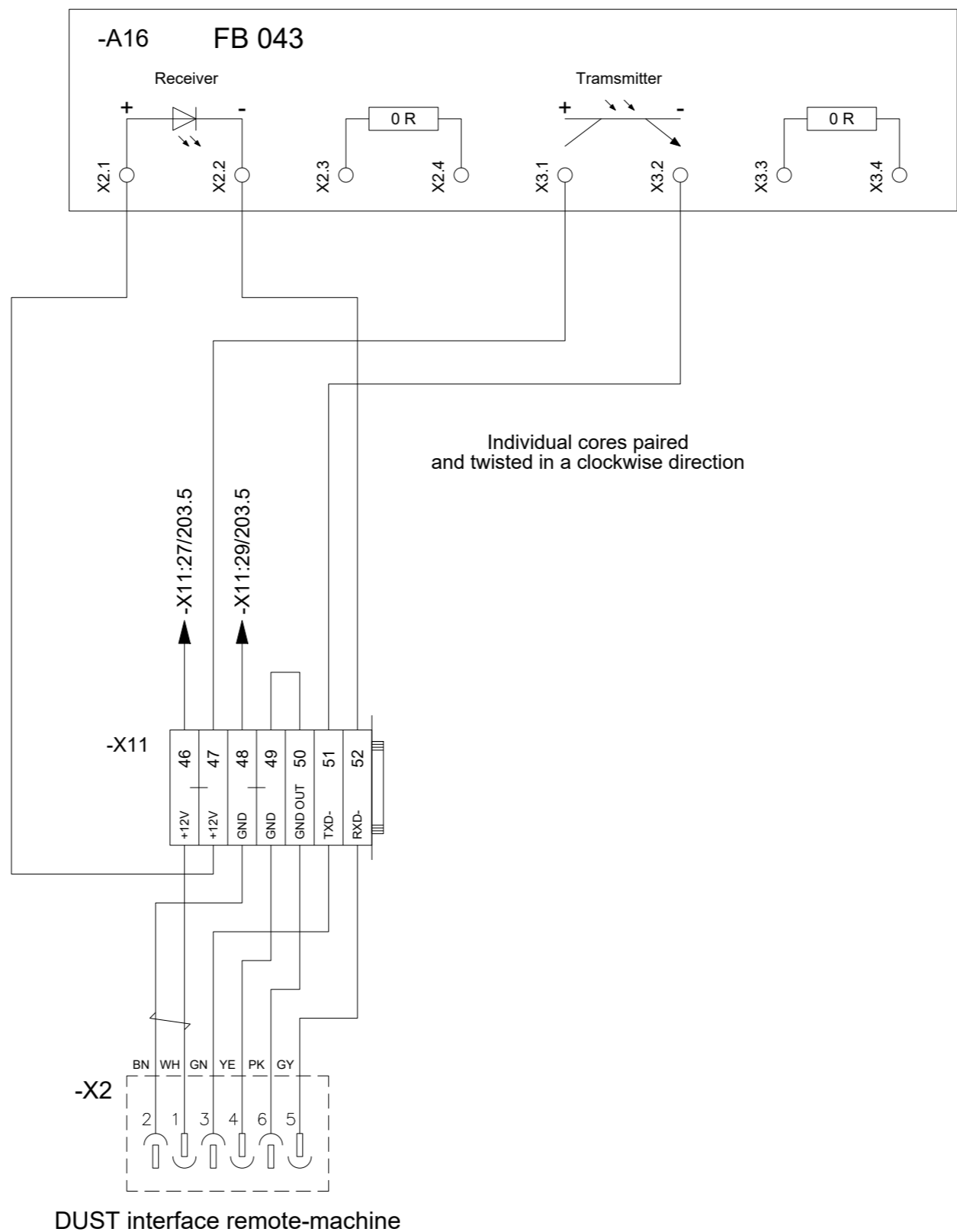

a				Date	19.07.2019
b				Drawn	J. Strauß
c				Chkd.	
Rev.	Modification	Date	Name	Norm	

becker
MINING SYSTEMS

Original	Subst. For	Replaced by
----------	------------	-------------

Becker MINING EUROPE GmbH
Walter-Becker-Straße 1
66299 Friedrichsthal

Wiring plan
FB 043 DUST module

Projekt title	44000011
Mining Master Smart	+
Drawing No.	Sheet206 +
G074-4080	18 Bl.

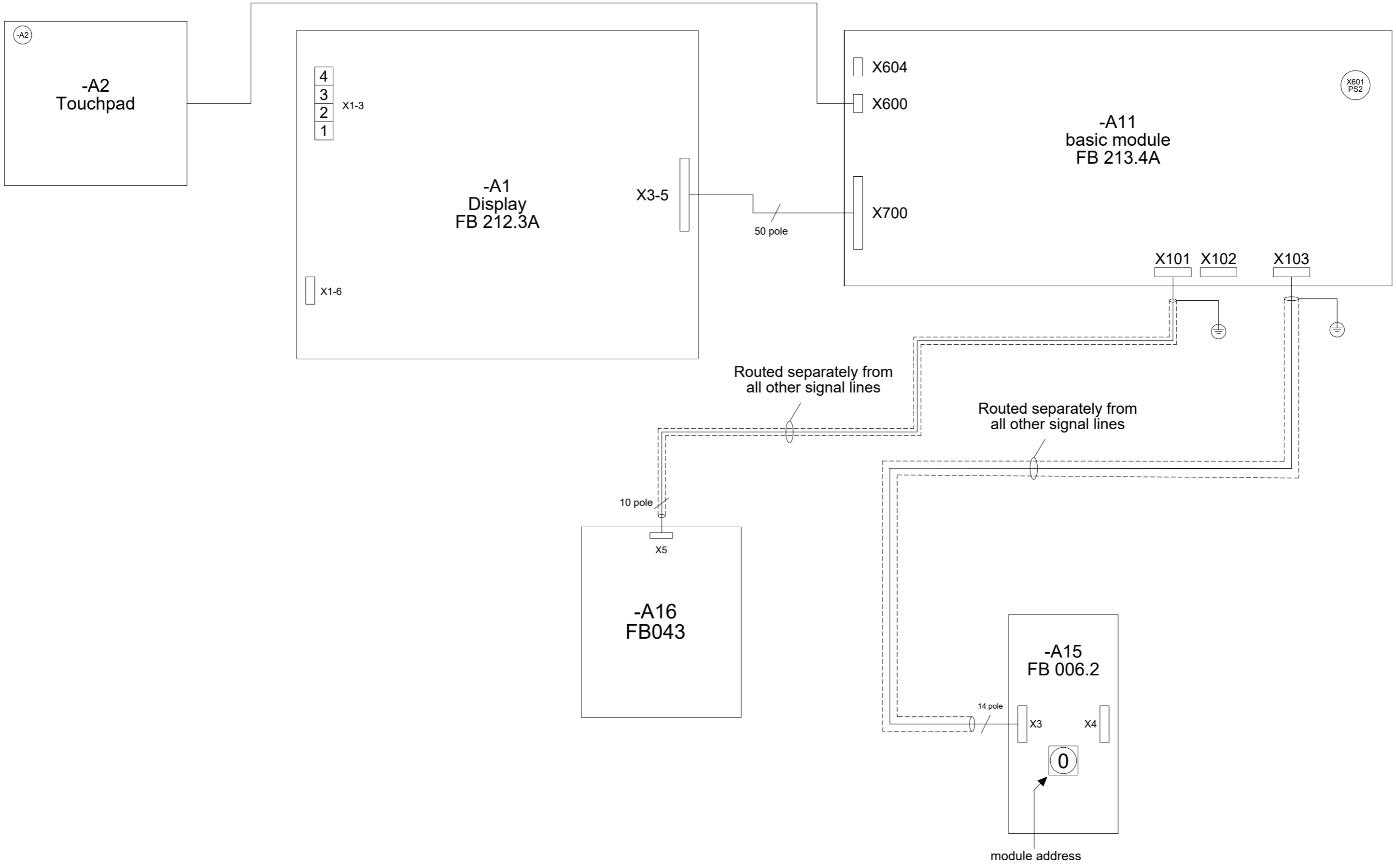

a				Date	19.07.2019		Becker MINING EUROPE GmbH Walter-Becker-Straße 1 66299 Friedrichsthal	Wiring plan Ribbon cable	Projekt title	= 44000011
b			Drawn	J. Strauß	Mining Master Smart				+	
c			Chkd.							
Rev.	Modification	Date	Name	Norm	Original	Subst. For	Replaced by		Drawing No. G074-4080	Sheet 207 + 18 Bl.

1 2 3 4 5 6 7 8

A

A

B

B

C

C

D

D

E

E

F

F

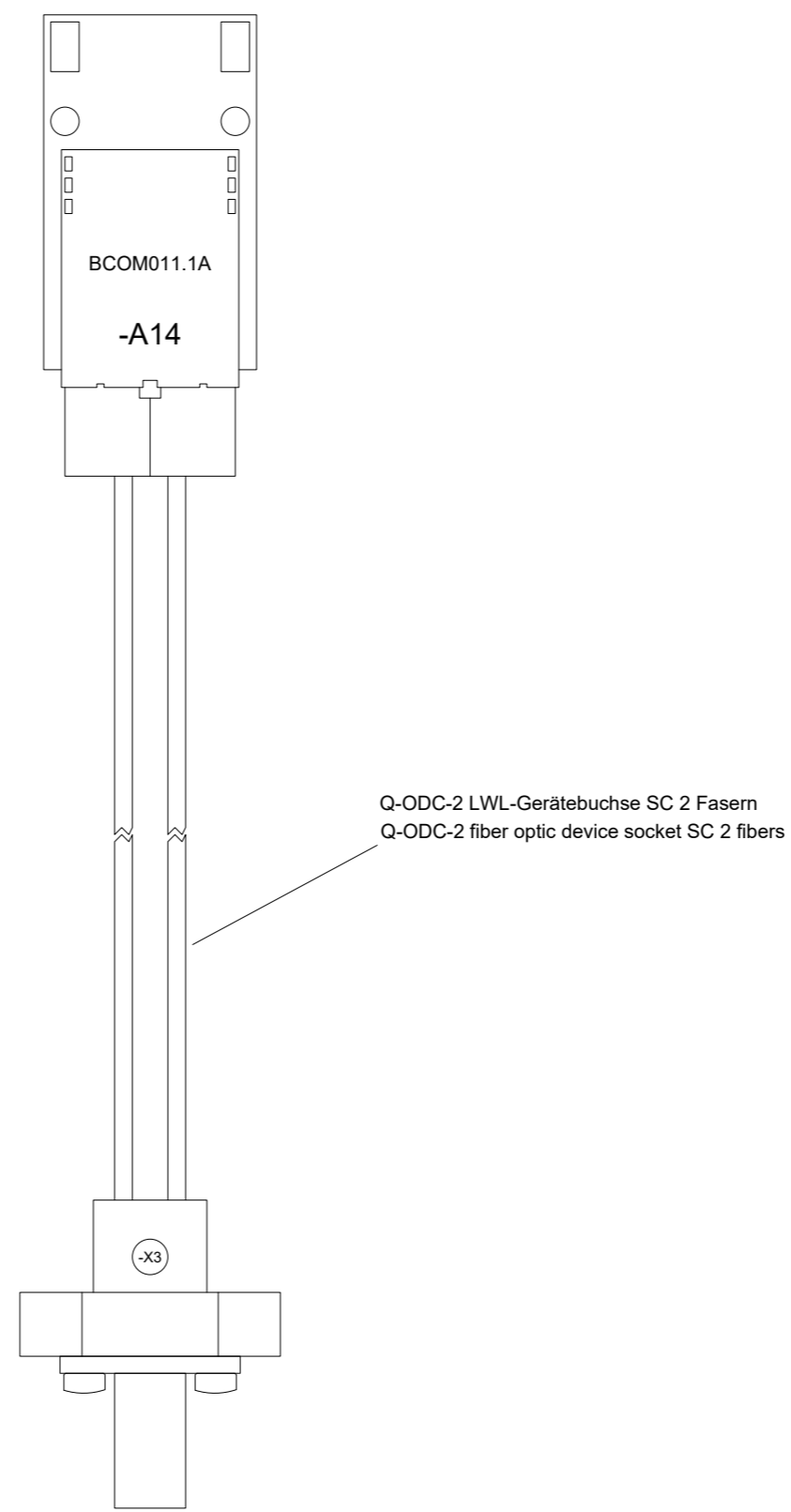

a				Date	19.07.2019		Becker MINING EUROPE GmbH Walter-Becker-Straße 1 66299 Friedrichsthal	Fiber optic connections Replaced by	Projekt title Mining Master Smart		= 4400011 +	
b			Drawn	J. Strauß	Drawing No. G074-4080				Sheet208 + 18 Bl.			
c			Chkd.		Original				Subst. For			
Rev.	Modification	Date	Name	Norm								

-A1

connection
Touchpad



X1-3

FB 212.3A
Display Mining Master Smart

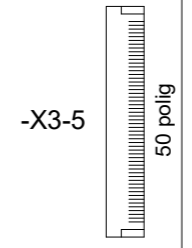

-X3-5

connection
basic module
Typ: FB213.*

I2C - Bus



X1-6

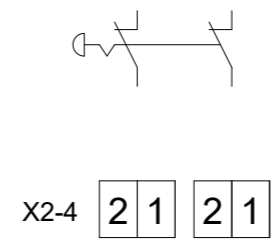
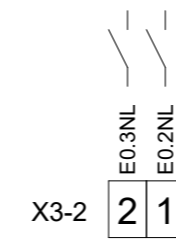
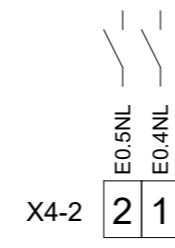
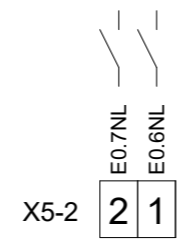
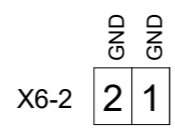

X3-4

8 INPUTS

EMERGENCY-STOP
Response
EMERGENCY-STOP
Safety circuit

a				Date	19.07.2019		Becker MINING EUROPE GmbH Walter-Becker-Straße 1 66299 Friedrichsthal	Data sheet Display	Projekt title		= 44000011 +
b			Drawn	J. Strauß	Mining Master Smart						
c			Chkd.		Drawing No.				Sheet300 +		
Rev.	Modification	Date	Name	Norm	Original	Subst. For	Replaced by		G074-4080		18 Bl.

-A11

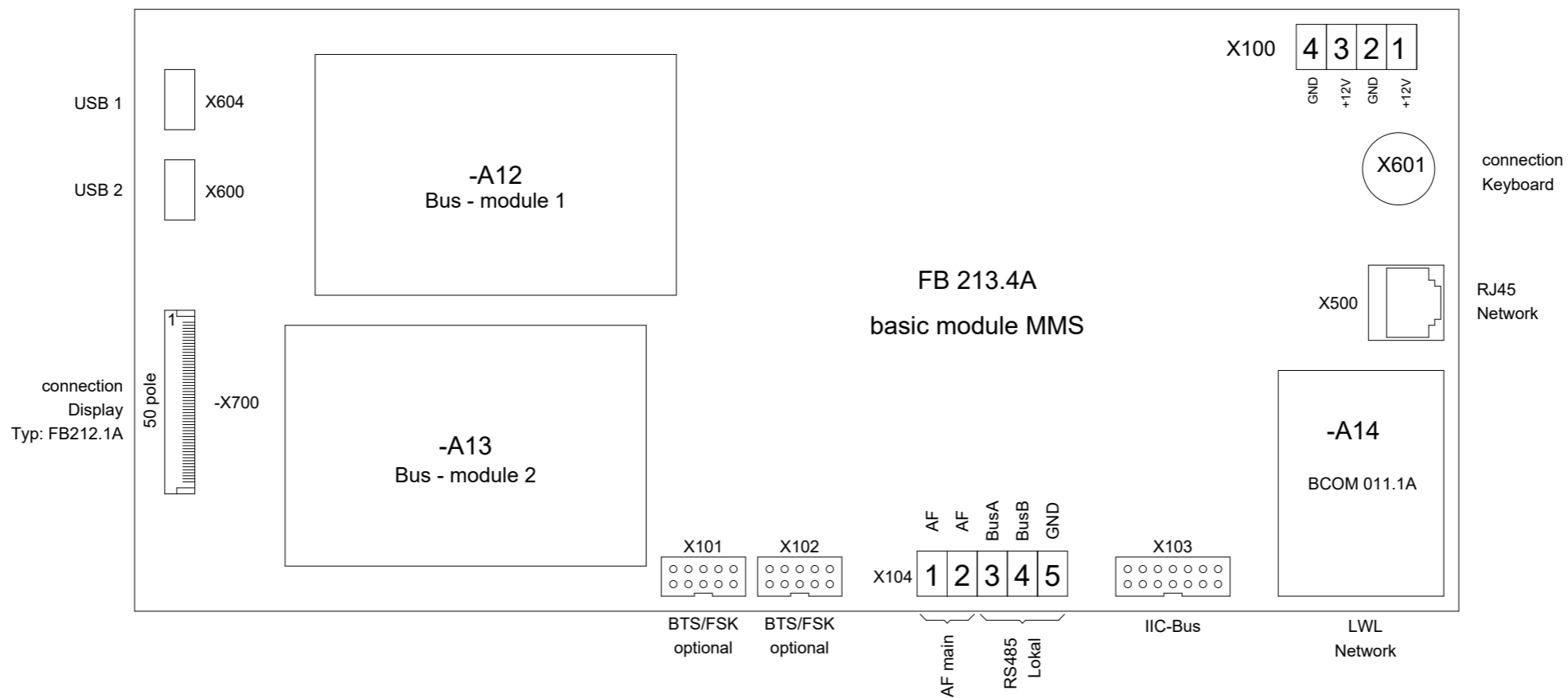

a				Date	19.07.2019
b				Drawn	J. Strauß
c				Chkd.	
Rev.	Modification	Date	Name	Norm	

becker
MINING EUROPE

Becker MINING EUROPE GmbH
Walter-Becker-Straße 1
66299 Friedrichsthal

Data sheet
MMS basic module

Projekt title	Mining Master Smart		= 44000011
Drawing No.	G074-4080	Sheet301 +	18 Bl.

-A15

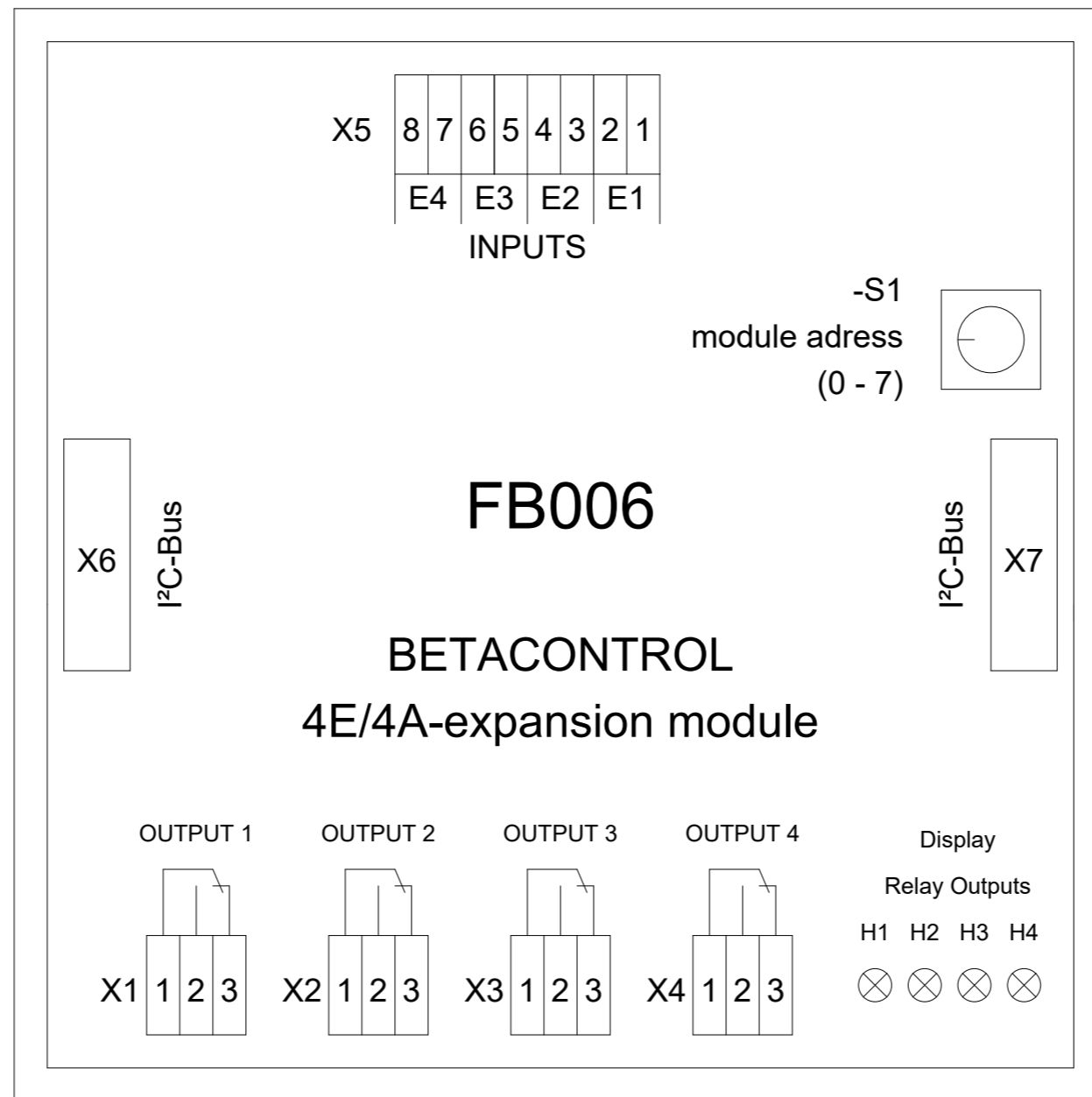

a				Date	19.07.2019		Becker MINING EUROPE GmbH Walter-Becker-Straße 1 66299 Friedrichsthal	Data sheet FB006	Projekt title		= 44000011
b			Drawn	J. Strauß	Mining Master Smart				+		
c			Chkd.								
Rev.	Modification	Date	Name	Norm	Original	Subst. For	Replaced by	Drawing No.		Sheet302 +	
								G074-4080		18 Bl.	

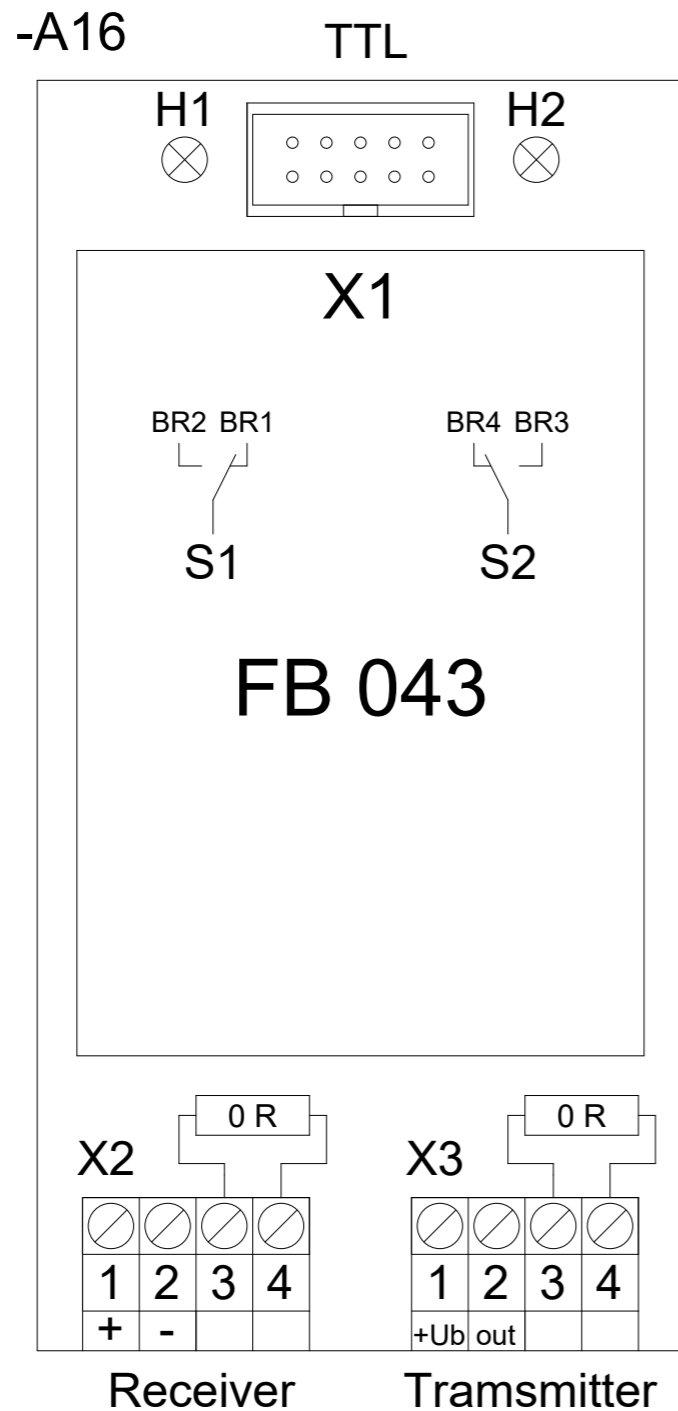

H1 lights when the receiver line-current power off

H2 lights when transmitter = log 0

S1 - phasing receiver signal

BR1 - line-current on = 1 (default setting)

BR2 - inverted

S2 - phasing transmitter signal

BR4 - line-current on = 1 (default setting)

BR3 - inverted

a				Date	19.07.2019		Becker MINING EUROPE GmbH Walter-Becker-Straße 1 66299 Friedrichsthal	Data sheet DUST module FB 043	Projekt title		= 44000011
b			Drawn	J. Strauß	Mining Master Smart				+		
c			Chkd.								
Rev.	Modification	Date	Name	Norm	Original	Subst. For	Replaced by	Drawing No.		Sheet303 -	
								G074-4080		18 Bl.	

Bill of material

no.	pos.	installation	location	device ID	Partnumber	Description	Specifications	page.row
1	0	44000011		A11	1000013024	MMSOF.02410 1xAST-1xBTS-SC/FO-OPC/ProV.		205.3
2	0	44000011		A14	5390020304	BCOM011.1A FO media converter		208.5
3	0	44000011		A15	5301006004	FB006.2 - 4E/4A Erweiterungsmodul		201.1
4	0	44000011		A16	5301212014	Display Board MMS (minimize)		200.2
5	0	44000011		A16	5301043014	20mA line current Interface		206.3
6	0	44000011		EW1	5207142220	End angle (EW15)		201.1
7	0	44000011		EW2	5207142220	End angle (EW15)		205.3
8	6	44000011		EW13	5207142220	End angle (EW15)		209.3
9	6	44000011		EW14	5207142220	End angle (EW15)		204.3
10	0	44000011		KF2	5101013520	1N4007-SII-Diode-1A		209.4
11	0	44000011		KF3	5101013520	1N4007-SII-Diode-1A		204.4
12	0	44000011		S1	NP2-BA31	Pushbutton green		200.5
13	0	44000011		S2	NP2-BA41	Pushbutton red		200.5
14	0	44000011		S3	NP2-BA61	Pushbutton blue		200.5
15	0	44000011		S4	M22-WK3	3 position switch		200.4
16	0	44000011		V1	5101013520	1N4007-SII-Diode-1A		203.3
17	0	44000011		V3	5101013520	1N4007-SII-Diode-1A		201.1
18	0	44000011		V4	5101013520	1N4007-SII-Diode-1A		201.3
19	0	44000011		V5	5101013520	1N4007-SII-Diode-1A		201.4
20	0	44000011		V6	5101013520	1N4007-SII-Diode-1A		201.6
21	0	44000011		X1	5391200104	BN4112AT 7-pin socket M25 x 1.5		203.4
22	1	44000011		X2	5391200304	ME2A10 socket 6p rotatable M25x1, 5 200cm		206.3
23	0	44000011		X3	1000013186	Q-ODC-2 fiber optic device socket SC 2 fibers		208.5
24	4	44000011		X12	5391200504	BS08D mounting socket 60cm 8 pin M25x1,5		209.4

a			Date	19.07.2019		Becker MINING EUROPE GmbH Walter-Becker-Straße 1 66299 Friedrichsthal	Bill of material Replaced by	Projekt title	Mining Master Smart		=
b			Drawn	J. Strauß				Drawing No.	G074-4080		+
c			Chkd.					Sheet500	+ 0 Bl.		
Rev.	Modification	Date	Name	Norm	Original	Subst. For					

